



Figure can vary

Part no.: 68042309
MLC520R30-900-EX2
Safety light curtain receiver



Contents

- Technical data
- Suitable transmitters
- Dimensioned drawings
- Electrical connection
- Circuit diagrams
- Operation and display
- Part number code
- Accessories
- Notes

Technical data

Basic data	
Series	MLC 500
Device type	Receiver
Contains	2x BT-NC sliding block
Application	Hand protection
Functions	
Function package	Standard
Functions	Transmission channel changeover Start/restart interlock (RES) Contactor monitoring (EDM)
Characteristic parameters	
Type	4, IEC/EN 61496
SIL	3, IEC 61508
SILCL	3, IEC/EN 62061
Performance Level (PL)	e, EN ISO 13849-1
PFH _D	7.73E-09 per hour
Mission time T _M	20 years, EN ISO 13849-1
Category	4, EN ISO 13849
Protective field data	
Resolution	30 mm
Protective field height	900 mm
Optical data	
Synchronization	Optical between transmitter and receiver
Electrical data	
Protective circuit	Short circuit protected Overvoltage protection
Performance data	
Supply voltage	24 V, DC, -20 ... 20 %
Current consumption, max.	150 mA
Fuse	2 A semi time-lag
Inputs	
Number of digital switching inputs	3 Piece(s)
Switching inputs	
Type	Digital switching input
Switching voltage high, min.	18 V
Switching voltage low, max.	2.5 V
Switching voltage, typ.	22.5 V
Voltage type	DC

Outputs

Number of safety-related switching outputs (OSSDs) 2 Piece(s)

Safety-related switching outputs

Type	Safety-related switching output OSSD
Switching voltage high, min.	18 V
Switching voltage low, max.	2.5 V
Switching voltage, typ.	22.5 V
Voltage type	DC
Current load, max.	380 mA
Load inductivity	2,000 μ H
Load capacity	0.3 μ F
Residual current, max.	0.2 mA
Residual current, typ.	0.002 mA
Voltage drop	1.5 V

Safety-related switching output 1

Assignment	Connection 1, pin 5
Switching element	Transistor, PNP

Safety-related switching output 2

Assignment	Connection 1, pin 6
Switching element	Transistor, PNP

Timing

Response time	9 ms
Restart delay time	100 ms

Connection

Number of connections 1 Piece(s)

Connection 1

Type of connection	Connector
Function	Machine interface
Thread size	M12
Material	Metal
No. of pins	8 -pin

Cable properties

Permissible conductor cross section, typ.	0.25 mm ²
Length of connection cable, max.	100 m
Permissible cable resistance to load, max.	200 Ω

Mechanical data

Dimension (W x H x L)	30.7 mm x 966 mm x 40.3 mm
Housing material	Metal, Aluminum
Lens cover material	Plastic / PMMA
Material of end caps	Diecast zinc
Net weight	1,050 g
Housing color	Yellow, RAL 1021
Type of fastening	Mounting on Device Column Mounting bracket Swivel mount Groove mounting

Operation and display

Part no.: 68042309 – MLC520R30-900-EX2 – Safety light curtain receiver

Type of display	LED 7-segment display
Number of LEDs	2 Piece(s)

Environmental data

Ambient temperature, operation	0 ... 55 °C
Ambient temperature, storage	-30 ... 70 °C
Relative humidity (non-condensing)	0 ... 95 %

Ex specification

Ex device category	3D 3G
Ex-zone	2 22
Ex device group	II
Permissible surface temperature	T<85° (T4) °C
Ignition protection type	"nA" non-sparking "tc" protection through housing

Certifications

Degree of protection	IP 65
Protection class	III
Certifications	c TÜV NRTL US TÜV Süd
Vibration resistance	50 m/s ²
Shock resistance	100 m/s ²
US patents	US 6,418,546 B

Classification

eCl@ss 8.0	27272704
eCl@ss 9.0	27272704
ETIM 5.0	EC002549

Suitable transmitters

	Part no.	Designation	Article	Description
	68040309	MLC500T30-900-EX2	Safety light curtain transmitter	Resolution: 30 mm Protective field height: 900 mm Operating range: 0 ... 10 m Connection: Connector, M12, Metal, 5 -pin

Dimensioned drawings

All dimensions in millimeters

Calculation of the effective protective field height $H_{PFE} = H_{PFN} + B + C$

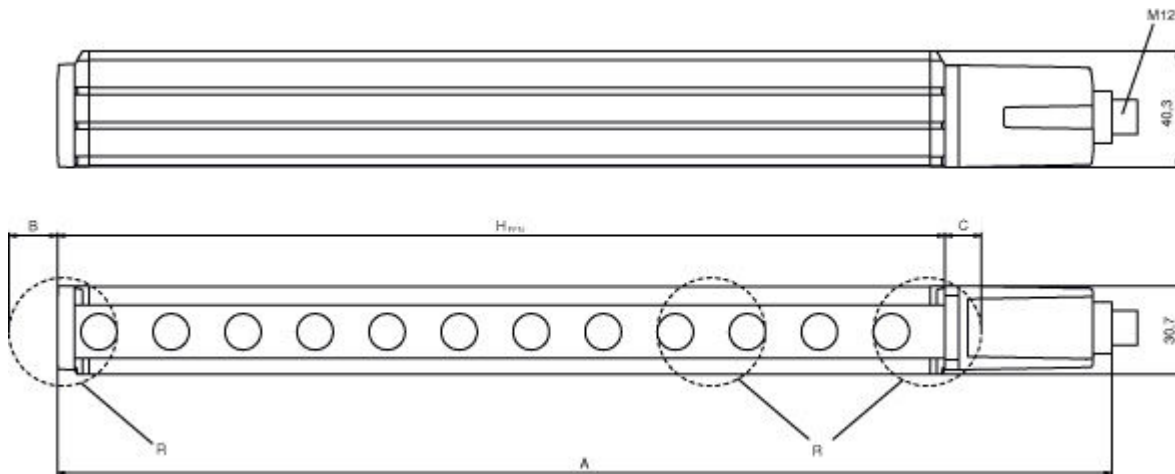

- HPFE Effective protective field height = 928 mm
- HPFN Nominal protective field height = 900 mm
- A Total height = 1566 mm
- B 19 mm
- C 9 mm
- R Effective protective field height H_{PFE} goes beyond the dimensions of the optics area to the outer borders of the circles labeled with R.

K-VM12-Ex interlocking guard

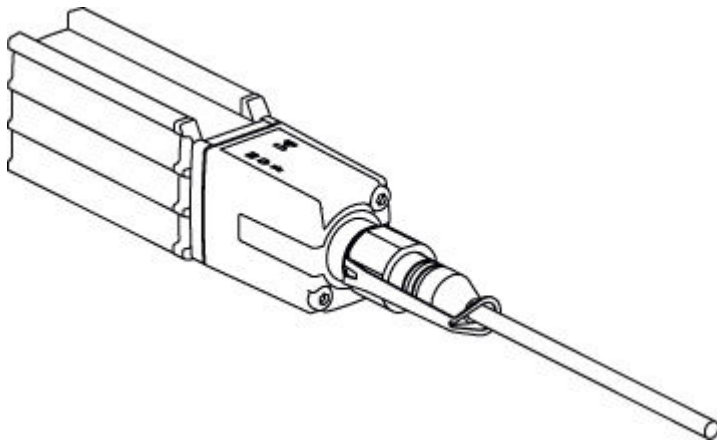

Electrical connection

Connection 1	
Type of connection	Connector
Function	Machine interface
Thread size	M12
Type	Male
Material	Metal
No. of pins	8 -pin
Encoding	A-coded
Connector housing	FE/SHIELD

Pin	Pin assignment	Conductor color
1	IO1	White
2	VIN1	Brown
3	IN3	Green
4	IN4	Yellow
5	OSSD1	Gray
6	OSSD2	Pink
7	VIN2	Blue
8	IN8	Red

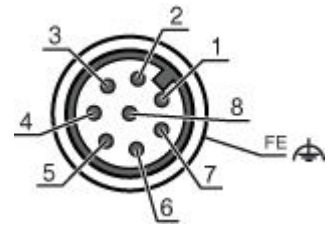

Circuit diagrams

Connection diagram receiver

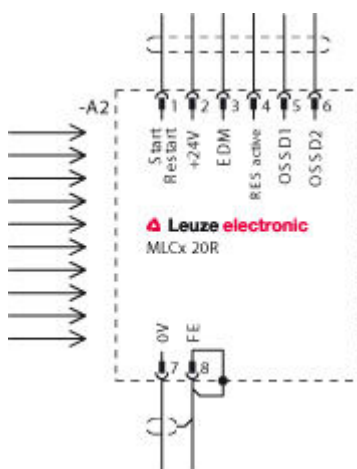

- VIN1 = +24 V, VIN2 = 0 V: transmission channel C1
- VIN1 = 0 V, VIN2 = +24 V: transmission channel C2

Circuit diagram example with downstream MSI-RM2 safety relay



Operation and display

LEDs

LED	Display	Meaning
1	Off	Device switched off
	Red, continuous light	OSSD off
	Red, flashing, 1 Hz	External error
	Red, flashing, 10 Hz	Internal error
	Green, flashing, 1 Hz	OSSD on, weak signal
	Green, continuous light	OSSD on
2	Off	RES deactivated or RES activated and enabled or RES blocked and protective field interrupted
	Red, continuous light	RES activated and blocked but ready to be unlocked - protective field free and linked sensor is enabled if applicable

Part number code

Part designation: MLCxyy-za-hhhhei-ooo

MLC	Safety light curtain
x	Series: 3: MLC 300 5: MLC 500

MLC	Safety light curtain
yy	Function classes: 00: Transmitter 01: transmitter (AIDA) 02: Transmitter with test input 10: Basic receiver - automatic restart 11: basic receiver - automatic restart (AIDA) 20: Standard receiver - EDM/RES selectable 30: Extended receiver - blanking/muting
z	Device type: T: transmitter R: receiver
a	Resolution: 14: 14 mm 20: 20 mm 30: 30 mm 40: 40 mm 90: 90 mm
hhhh	Protective field height: 150 ... 3000: from 150 mm to 3000 mm
e	Host/Guest (optional): H: Host MG: Middle Guest G: Guest
i	Interface (optional): /A: AS-i
ooo	Option: /V: high Vibration-proof EX2: explosion protection (zones 2 + 22) SPG: Smart Process Gating

Note





A list with all available device types can be found on the Leuze electronic website at www.leuze.com.

Accessories

Connection technology - Connection cables

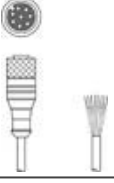
	Part no.	Designation	Article	Description
	429288	CB-M12-25000-8GF	Connection cable	Connection 1: Connector, M12, Axial, Female, A-coded, 8 -pin Connection 2: Open end Shielded: No Cable length: 25,000 mm Sheathing material: PUR
	429289	CB-M12-50000-8GF	Connection cable	Connection 1: Connector, M12, Axial, Female, A-coded, 8 -pin Connection 2: Open end Shielded: No Cable length: 50,000 mm Sheathing material: PUR
	50135128	KD S-M12-8A-P1-050	Connection cable	Connection 1: Connector, M12, Axial, Female, A-coded, 8 -pin Connection 2: Open end Shielded: Yes Cable length: 5,000 mm Sheathing material: PUR
	50135129	KD S-M12-8A-P1-100	Connection cable	Connection 1: Connector, M12, Axial, Female, A-coded, 8 -pin Connection 2: Open end Shielded: Yes Cable length: 10,000 mm Sheathing material: PUR

Part no.: 68042309 – MLC520R30-900-EX2 – Safety light curtain receiver

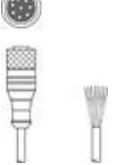
	Part no.	Designation	Article	Description
	50135130	KD S-M12-8A-P1-150	Connection cable	Connection 1: Connector, M12, Axial, Female, A-coded, 8 -pin Connection 2: Open end Shielded: Yes Cable length: 15,000 mm Sheathing material: PUR
	50135131	KD S-M12-8A-P1-250	Connection cable	Connection 1: Connector, M12, Axial, Female, A-coded, 8 -pin Connection 2: Open end Shielded: Yes Cable length: 25,000 mm Sheathing material: PUR
	50135132	KD S-M12-8A-P1-500	Connection cable	Connection 1: Connector, M12, Axial, Female, A-coded, 8 -pin Connection 2: Open end Shielded: Yes Cable length: 50,000 mm Sheathing material: PUR
	50135122	KD U-M12-8A-P1-050	Connection cable	Connection 1: Connector, M12, Axial, Female, A-coded, 8 -pin Connection 2: Open end Shielded: No Cable length: 5,000 mm Sheathing material: PUR
	50135123	KD U-M12-8A-P1-100	Connection cable	Connection 1: Connector, M12, Axial, Female, A-coded, 8 -pin Connection 2: Open end Shielded: No Cable length: 10,000 mm Sheathing material: PUR
	50135124	KD U-M12-8A-P1-150	Connection cable	Connection 1: Connector, M12, Axial, Female, A-coded, 8 -pin Connection 2: Open end Shielded: No Cable length: 15,000 mm Sheathing material: PUR

Connection technology - Connectors

	Part no.	Designation	Article	Description
	429178	CB-M12-8GF	Connector	Connection: Connector, M12, Axial, Female, A-coded, 8 -pin



Mounting technology - Mounting brackets

	Part no.	Designation	Article	Description
	429056	BT-2L	Mounting bracket set	Design of mounting device: Angle, L-shape Mounting bracket, at system: Through-hole mounting Mounting bracket, at device: Screw type Material: Metal







Part no.: 68042309 – MLC520R30-900-EX2 – Safety light curtain receiver

	Part no.	Designation	Article	Description
	429057	BT-2Z	Mounting bracket set	Design of mounting device: Angle, Z-shape Mounting bracket, at system: Through-hole mounting Mounting bracket, at device: Screw type Material: Metal

Mounting technology - Swivel mounts

	Part no.	Designation	Article	Description
	429393	BT-2HF	Mounting bracket set	Contains: 2x BT-HF swivel mount, 1 cylinder for mounting on the light curtain Mounting bracket, at system: Through-hole mounting Mounting bracket, at device: Clampable Type of mounting device: Turning, 360° Material: Metal, Plastic
	429394	BT-2HF-S	Mounting bracket set	Contains: 2x BT-HF swivel mount, 1 cylinder for mounting on the light curtain Mounting bracket, at system: Through-hole mounting Mounting bracket, at device: Clampable Type of mounting device: Turning, 360° Material: Metal, Plastic Shock absorber: Yes

Mounting technology - Other





	Part no.	Designation	Article	Description
	425740	BT-10NC60	Sliding block set	Contains: 10x BT-NC sliding block Bore hole 1: Ø 4.7 mm Bore hole 2: M6 Design of mounting device: Sliding block Mounting bracket, at system: Mounting thread Mounting bracket, at device: Groove mounting Material: Metal
	425741	BT-10NC64	Sliding block set	Contains: 10x BT-NC-M4-M6 sliding block Bore hole 1: M4 Bore hole 2: M6 Design of mounting device: Sliding block Mounting bracket, at system: Mounting thread Mounting bracket, at device: Groove mounting Material: Metal
	425742	BT-10NC65	Sliding block set	Contains: 10x BT-NC-M5-M6 sliding block Bore hole 1: M5 Bore hole 2: M6 Design of mounting device: Sliding block Mounting bracket, at system: Mounting thread Mounting bracket, at device: Groove mounting Material: Metal
	424417	BT-2P40	Mounting bracket set	Contains: 2x BT-P40 clamp bracket Design of mounting device: Mounting clamp Mounting bracket, at system: Groove mounting Mounting bracket, at device: Groove mounting Type of mounting device: Clampable Material: Metal
	424422	BT-2SB10	Mounting bracket set	Contains: 2x BT-SB10 Design of mounting device: Mounting clamp Mounting bracket, at system: Through-hole mounting Mounting bracket, at device: Clampable, an der seitlichen C-Nut Type of mounting device: Swiveling Swivel range: -8 ... 8° Material: Metal
	424423	BT-2SB10-S	Mounting bracket set	Contains: 2x BT-SB10-S Design of mounting device: Mounting clamp Mounting bracket, at system: Through-hole mounting Mounting bracket, at device: Clampable, an der seitlichen C-Nut Swivel range: -8 ... 8° Material: Metal Shock absorber: Yes

Part no.: 68042309 – MLC520R30-900-EX2 – Safety light curtain receiver

Test rods

	Part no.	Designation	Article	Description
	349945	AC-TR14/30	Test piece	Diameter 1: 14 mm Diameter 2: 30 mm Housing material: Plastic, ABS

Alignment aids

	Part no.	Designation	Article	Description
	427300	AC-ALM	Alignment aid	Housing material: Plastic
	520101	AC-ALM-M	Alignment aid	Housing material: Plastic
	560020	LA-78U	Alignment aid	Light source: laser, Red Housing material: Metal
	520004	LA-78UDC	Alignment aid	Light source: laser, Red Housing material: Metal





Deflecting mirror

	Part no.	Designation	Article	Description
	529609	UM60-900	Deflecting mirror	Dimensions: 25 mm x 970 mm x 68 mm Protected field height up to: 900 mm Mirror length: 960 mm

Device columns

	Part no.	Designation	Article	Description
	549852	UDC-1300-S2	Device column	Dimensions: 160 mm x 1,360 mm x 149 mm Column height without foot: 1,300 mm Functions: Mounting and protection of light curtains and multiple light beam devices, Adjustable, 3 directions

Part no.: 68042309 – MLC520R30-900-EX2 – Safety light curtain receiver

	Part no.	Designation	Article	Description
	549853	UDC-1600-S2	Device column	Dimensions: 160 mm x 1,660 mm x 149 mm Column height without foot: 1,600 mm Functions: Mounting and protection of light curtains and multiple light beam devices, Adjustable, 3 directions
	549854	UDC-1900-S2	Device column	Dimensions: 160 mm x 1,960 mm x 149 mm Column height without foot: 1,900 mm Functions: Mounting and protection of light curtains and multiple light beam devices, Adjustable, 3 directions
	549867	UDC-2100-S2	Device column	Dimensions: 160 mm x 2,160 mm x 149 mm Column height without foot: 2,100 mm Functions: Adjustable, 3 directions, Mounting and protection of light curtains and multiple light beam devices
	549857	UDC-2500-S2	Device column	Dimensions: 160 mm x 2,560 mm x 149 mm Column height without foot: 2,500 mm Functions: Adjustable, 3 directions, Mounting and protection of light curtains and multiple light beam devices
	549865	UDC-3100-S2	Device column	Dimensions: 160 mm x 3,160 mm x 149 mm Column height without foot: 3,100 mm Functions: Mounting and protection of light curtains and multiple light beam devices, Adjustable, 3 directions

General

	Part no.	Designation	Article	Description
	50109217	K-V M12-Ex	Safety locking device	Housing material: Plastic, PA

Notes

Observe intended use!
<ul style="list-style-type: none"> The product may only be put into operation by competent persons. Only use the product in accordance with its intended use.